

# The Auveco Green Catalog

**Hot Off  
The Press!!!**

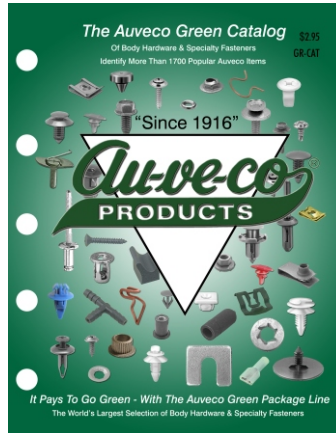

**Printed On Recycled Paper  
Because We're  
Environmentally  
Conscious**

## It Pays To Go Green – With The Auveco Green Package Line.

The Auveco Master Catalog with over 700 pages is regarded as **THE ENCYCLOPEDIA OF THE AUTOMOTIVE BODY HARDWARE INDUSTRY**. A catalog of this magnitude can be overwhelming. So we've boiled down our massive product line of over 18,000 items to our brand new **extremely handy (Mini) AUVECO GREEN CATALOG (part number GR-CAT)**.

Since it contains less than 1/5<sup>th</sup> the number of pages of the master catalog, the **AUVECO GREEN CATALOG** not only saves on paper but it presents over 1,700 of the most popular Auveco part numbers divided by product group into 45 different sections in a clear, concise format that makes it quick and easy to find the right part.

The **AUVECO GREEN CATALOG** features trilingual verbiage (English, Spanish and French-Canadian) and includes actual size pictures of all the products, O.E.M. numbers, pertinent specifications, dimensions, colors, plating information, etc.; all of which aids in identifying the correct Auveco part numbers and unit package quantities. The **AUVECO GREEN CATALOG** takes the guess work out of identifying Body Hardware and Specialty Fasteners.

There are 378 items with a ★ symbol which indicates these items are included on the Auveco DB-370 Plus Display Boards. The DB-370 Plus is a program of recommended stocking items for all of our Distributors.

We included the "AP" AuvecoPak part number wherever applicable for those customers that have the AuvecoPak Retail Merchandiser.

Order your copies of the **AUVECO GREEN CATALOG** today.

**Remember The Auveco Master Catalog Is Available For A Listing Of Our Entire Line**

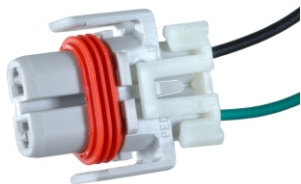

### 21220

(GM: 88987187)

Headlight Socket Assembly For H9 Halogen Bulb (Auveco No. 21222) GM, Audi, Mazda, Mini-Cooper, Porsche, Volkswagen & Volvo

UNIT PACKAGE: 1



### 21210

Not Available From O.E.M.

Universal Headlight Harness Connector For H7 Halogen Bulbs; Two 18 Gauge 6" Long Leads; Ford, Audi, BMW, Hyundai, Kia, Mazda, Mercedes, Mini Cooper, Saab & Subaru

UNIT PACKAGE: 1



### 21212

(88988609)

Window Motor Regulator Harness Connector Two 12 Gauge 10" Long Leads GM 1995 - On

UNIT PACKAGE: 1

### PREMIUM IMPORTED HALOGEN LIGHT BULB



Not Actual Size

### 21222

H9 Bulb High Beam 12 Volts, 65 Watts Use with Auveco Headlight Socket 21220

UNIT PACKAGE: 1





### 21258

(Ford: F4XY-6734-A;  
Nissan: 11026-01M02)

Oil Drain Plug Gasket  
Copper Crushable  
I.D.: 12mm, O.D.: 17.7mm  
Thickness: 3mm  
Used with M12-1.25 Oil Drain Plugs  
On Mercury Villager and  
Nissan 350Z & Sentra 2009 - 2000  
UNIT PACKAGE: 10



### 21245

(W705297-S300)

Bumper Cover  
Split-Type Rivet  
1/4" Diameter  
Grip Range: 3/16" - 3/8"  
Flange Diameter: 11/16"  
Aluminum Rivet  
Aluminum Mandrel  
Ford Fusion  
2009 - On  
UNIT PACKAGE: 15

## 15 NEW QUIK-SELECT II ASSORTMENTS

(Refer to Auveco Catalog pages 301 - 303 for a listing of current Quik-Select II Assortments)

Take the step up in body hardware coverage with Auveco's Quik-Select II assortments.



**Quik-Select II's feature a polypropylene box that's larger (13-1/16" Wide x 8-13/16" Deep x 2-1/4" High) than our regular 6800 series Quik-Select assortments**, and thus not only provide a larger variety of parts in each assortment but they also contain a greater number of each part per compartment at a **reduced cost compared to the 6800 series Quik-Selects**.

The assortments come in 12, 18 and 24 compartment, translucent, durable polypropylene boxes with lid labels complete with O.E.M. numbers, sizes, product pictures and the Auveco part numbers for ordering refills.



### 6920

Black Tapping Screws  
24 Varieties - 490 Pieces

Auveco  
Part No.      Size

#### Black Oxide Phillips Oval Head

12897	#4 x 1"
12796	#6 x 3/4"
10162	#8 x 1/2" w/ #6 HD
10164	#8 x 3/4" w/ #6 HD
10165	#8 x 3/4"
10166	#8 x 1" w/ #6 HD
10167	#8 x 1"

#### Black Oxide Phillips Pan Head

11917	#6 x 1/2"
10180	#8 x 1/2"
10181	#8 x 3/4"
10182	#8 x 1"
12799	#8 x 1-1/2"
11921	#10 x 1/2"
11922	#10 x 3/4"
11923	#10 x 1"

#### Black E-Coat Phillips Flat Washer Head

12213	#8 x 1/2"
12214	#8 x 5/8"
12215	#8 x 3/4"
12216	#8 x 1"
12217	#8 x 1-1/4"
12218	#8 x 1-1/2"
12953	#10 x 3/4"
12954	#10 x 1"

#### Black Phos. Phillips Pan Head Sems

12820	#8 x 3/4"
-------	-----------



### 6921

Teks Screws  
18 Varieties - 520 Pieces

Auveco  
Part No.      Size

#### Phillips Pan Head

9605	#8 x 1/2"
9606	#8 x 3/4"
9608	#10 x 3/4"

#### Hex Washer Head

9611	#8 x 1/2"
9612	#8 x 3/4"
9613	#10 x 1/2"
9615	#10 x 3/4"
9616	#10 x 1"
11911	#12 x 1"
11914	#14 x 1"

#### Specialty Screws

12095	#8 x 1/2"
15172	#8 x 1/2"
15774	#8 x 1/2"
17460	#8 x 3/4"
17650	#8 x 3/4"
18261	M4.2-1.41 x 16mm
15775	M4.2-1.41 x 20mm
19006	M4.2-1.41 x 25mm



### 6922

Tubular, Flat, "U" & "J" Nuts  
24 Varieties - 313 Pieces

Auveco  
Part No.      Type

2595	1/8"	Tubular
11293	1/8"	Tubular
2089	#6-32	Flat
1899	#8-32	Flat
2092	#10-24	Flat
2099	1/8"	Flat
2103	3/16"	Flat
1903	1/4"-20	Flat
5586	1/4"-20	"J" Cage
5589	5/16"-18	"J" Cage
5170	3/8"-16	"J" Cage
10666	#8	"U"
11292	#8	"U"
2422	#10	"U"
14750	#10	Nylon "U"
2293	1/4"-20	"U"
14276	M6.3 (#14)	Nylon "U"
10064	#6	Spring "U"
9879	#8	Spring "U"
9880	#8	Spring "U"
10065	#8	Spring "U"
10066	#10	Spring "U"
15752	#10	Spring "U"
10067	#14	Spring "U"



**6923**

Extruded "U" Nuts  
18 Varieties - 125 Pieces

Auveco Part No.	Size	
10048	#8-32	3/8" Hole/Edge
10047	#8-32	9/16" Hole/Edge
15677	#10-24	15/32" Hole/Edge
8359	1/4"-20	17/32" Hole/Edge
10051	1/4"-20	25/32" Hole/Edge
10053	5/16"-18	9/16" Hole/Edge
8814	5/16"-18	27/32" Hole/Edge
10054	3/8"-16	3/4" Hole/Edge
10055	3/8"-16	1-1/8" Hole/Edge
11626	M5-.8	15.8mm Hole/Edge
16846	M6-1.0	12mm Hole/Edge
16842	M6-1.0	13.5mm Hole/Edge
12669	M6-1.0	13.5mm Hole/Edge
12575	M6-1.0	19.5mm Hole/Edge
11628	M6.3-1.0	13.5mm Hole/Edge
11629	M8-1.25	14.5mm Hole/Edge
11630	M8-1.25	20mm Hole/Edge
11631	M10-1.5	19mm Hole/Edge



**6924**

Washer Lock Nuts,  
Thread Cutting Nuts,  
Push-On Retainers &  
Pushnut Bolt Retainers  
24 Varieties - 489 Pieces

Auveco Part No.	Size
-----------------	------

**Thread Cutting Nuts**

12253	5mm	Stud Size
3403	1/8"	Stud Size
3404	3/16"	Stud Size
2896	3/16"	Stud Size
2897	1/4"	Stud Size
3405	1/4"	Stud Size
10733	5/16"	Stud Size

**Washer Lock Nuts**

2557	#10-24	1/2 OD
2558	#10-24	3/4 OD

**Push-On Retainers**

8863	1/8"	Stud Size
8864	5/32"	Stud Size
8865	3/16"	Stud Size
8868	1/4"	Stud Size
8869	5/16"	Stud Size
10374	3/8"	Stud Size

**Pushnut Bolt Retainers**

10086	1/4"	Bolt Size
10087	5/16"	Bolt Size
9297	3/8"	Bolt Size
9299	1/2"	Bolt Size
12122	M5-.8	Bolt Size
12123	M6-1.0	Bolt Size
12125	M8-1.25	Bolt Size
12127	M12-1.75	Bolt Size
14980	M14-2.0	Bolt Size



**6926**

"E" Type Retaining Rings  
12 Varieties - 445 Pieces

Auveco Part No.	Size
-----------------	------

8826	1/8"
10131	5/32"
8827	3/16"
10133	7/32"
8828	1/4"
3824	5/16"
8829	3/8"
8830	7/16"
5602	1/2"
5603	5/8"
8831	3/4"
8833	1"



**6925**

External & Internal Retaining Rings  
Zinc Plated

24 Varieties - 218 Pieces

Auveco

Part No. Size

**Internal Retaining Rings**

8688	1/4"
8689	5/16"
8690	3/8"
8692	1/2"
8694	5/8"
8695	3/4"
8696	7/8"
8697	1"

**External Retaining Rings**

8701	1/4"
8702	5/16"
8703	3/8"
8704	7/16"
8705	1/2"
8706	9/16"
8707	5/8"
10120	11/16"
8708	3/4"
8709	7/8"
8710	1"
8711	1-1/8"
8712	1-1/4"
10125	1-1/2"
16745	1-5/8"
10127	2"

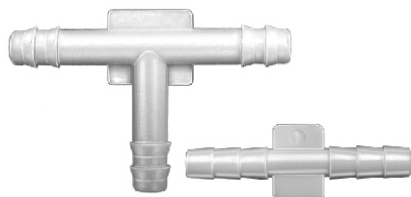

**6930**

Nylon Connectors  
24 Varieties - 215 Pieces

Auveco Part No.	Size	
10101	1/8" x 1/8"	Straight
12929	1/8" x 1/8"	Straight
12930	1/8" x 3/16"	Straight
12936	1/8" x 1/4"	Straight
10102	3/16" x 3/16"	Straight
12937	3/16" x 3/16"	Straight
10103	1/4" x 1/4"	Straight
12935	3/16" x 1/4"	Straight
12931	1/4" x 1/4"	Straight
10104	5/16" x 5/16"	Straight
12946	5/16" x 5/16"	Straight
10105	3/8" x 3/8"	Straight
12923	1/8" x 1/8" x 1/8"	Tee
10108	5/32" x 5/32" x 5/32"	Tee
12926	3/16" x 1/8" x 3/16"	Tee
10109	3/16" x 3/16" x 3/16"	Tee
12918	3/16" x 3/16" x 3/16"	Tee
12919	1/4" x 3/16" x 3/16"	Tee
10110	1/4" x 1/4" x 1/4"	Tee
12921	3/8" x 1/4" x 3/8"	Tee
12920	5/16" x 5/16" x 5/16"	Tee
11228	3/8" x 3/8" x 3/8"	Tee
12927	3/16" x 3/16" x 3/16"	Y
12932	3/16" x 3/16"	Elbow



**6933**

Rubber Grommets  
24 Varieties - 252 Pieces

Auveco Part No.	Size
-----------------	------

4408	1/8" Bore,	3/32" Width
4410	5/32" Bore,	1/16" Width
4413	3/16" Bore,	1/16" Width
4414	3/16" Bore,	3/32" Width
4415	3/16" Bore,	1/4" Width
16454	1/4" Bore,	1/16" Width
4417	1/4" Bore,	1/16" Width
4419	5/16" Bore,	1/16" Width
4420	5/16" Bore,	1/16" Width
4421	5/16" Bore,	1/8" Width
4422	5/16" Bore,	1/4" Width
4423	3/8" Bore,	1/16" Width
16456	3/8" Bore,	1/16" Width
4425	3/8" Bore,	1/16" Width
4426	3/8" Bore,	1/4" Width
4428	1/2" Bore,	3/32" Width
4429	1/2" Bore,	3/32" Width
16458	1/2" Bore,	1/8" Width
4430	1/2" Bore,	1/4" Width
4431	5/8" Bore,	1/8" Width
4432	5/8" Bore,	1/16" Width
4433	3/4" Bore,	1/16" Width
4434	3/4" Bore,	1/16" Width
4436	3/4" Bore,	1/4" Width



### 6932

Pan'l Blind Rivets  
18 Varieties - 480 Pieces

Auveco Part No.	Size
<b>1/8" Diameter; Aluminum/Aluminum</b>	
8309	Grip: 1/16" - 1/8"
8925	Grip: 3/16" - 1/4"
8931	Grip: 3/16" - 1/4"
16031	Grip: 5/16" - 3/8"
16032	Grip: 3/8" - 1/2"
<b>1/8" Diameter; Steel/Steel</b>	
11104	Grip: 3/16" - 1/4" (Stainless Steel)
5753	Grip: 3/16" - 1/4"
8293	Grip: 3/16" - 1/4"
8880	Grip: 5/16" - 3/8"
<b>5/32" Diameter; Aluminum/Aluminum</b>	
18729	Grip: 3/16" - 1/4"
18732	Grip: 3/16" - 1/4"
18730	Grip: 1/4" - 3/8"
<b>3/16" Diameter; Aluminum/Aluminum</b>	
8311	Grip: 1/8" - 1/4"
19055	Grip: 1/16" - 1/4"
8301	Grip: 1/4" - 3/8"
8313	Grip: 1/4" - 3/8"
8938	Grip: 3/8" - 1/2"
19056	Grip: 3/8" - 1/2"

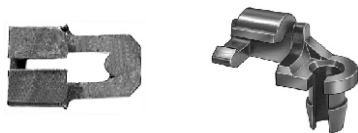

### 6934

Door Lock Rod Clips  
18 Varieties - 152 Pieces

10262, 14359, 14365, 14967,  
15518, 15673, 15674, 15675,  
15759, 17122, 18392, 18393,  
18926, 19658, 20469, 20470,  
20534 & 20535

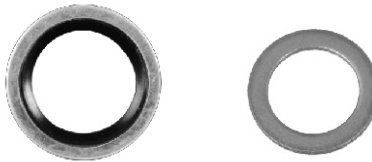

### 6931

Oil Drain Plug Gaskets  
18 Varieties - 153 Pieces

Auveco Part No.	Size	
8277	1/2"	Nylon
15918	1/2"	Copper
15919	9/16"	Copper
16026	1/2"	Steel & Rubber
16682	14mm	Black Fibre
16955	18mm	Aluminum
16956	14mm	Aluminum
16996	1/2"	Nylon
17261	12mm	Copper
17262	14mm	Copper
17264	18mm	Copper
17265	20mm	Copper
17628	12mm	Green Fibre
18299	14mm	Steel & Rubber
18665	11mm	Rubber
18726	12mm	Black Fibre
19630	11mm	Rubber
20453	13mm	Rubber



### 6929

Rubber Vacuum Caps  
12 Varieties - 332 Pieces

Auveco Part No.	Size	
<b>Rubber Vacuum Caps</b>		
12209	Fits 1/8"	O.D. Tube
4440	Fits 3/16"	O.D. Tube
4439	Fits 1/4"	O.D. Tube
19001	Fits 1/4"	O.D. Tube
12907	Fits 5/16"	O.D. Tube
19002	Fits 5/16"	O.D. Tube
12210	Fits 3/8"	O.D. Tube
12908	Fits 1/2"	O.D. Tube
<b>Vinyl Vacuum Caps</b>		
18202	Fits 3/16"	O.D. Tube
18203	Fits 1/4"	O.D. Tube
18204	Fits 5/16"	O.D. Tube
18205	Fits 3/8"	O.D. Tube



### 6927

Zinc Plated Cotter Pins  
18 Varieties - 734 Pieces

Auveco Part No.	Size
8478	1/16" x 3/4"
8479	1/16" x 1"
8480	1/16" x 1-1/2"
8481	3/32" x 3/4"
8482	3/32" x 1"
8483	3/32" x 1-1/4"
8484	3/32" x 1-1/2"
8485	3/32" x 2"
8486	1/8" x 1"
8487	1/8" x 1-1/4"
8488	1/8" x 1-1/2"
8489	1/8" x 1-3/4"
8490	1/8" x 2"
8493	5/32" x 1-1/2"
8494	5/32" x 2"
8495	3/16" x 1-1/2"
8496	3/16" x 2"
8497	3/16" x 2-1/2"



### 6928

Plug Buttons  
18 Varieties - 238 Pieces

Auveco Part No.	Size	
<b>Depressed Center Type</b>		
9288	1/2"	Hole Size
9289	3/4"	Hole Size
9291	1"	Hole Size
<b>Flush Type</b>		
14923	3/8"	Hole Size
11746	1/2"	Hole Size
11747	3/4"	Hole Size
11749	1"	Hole Size
<b>Plug Buttons (Nickel Plated)</b>		
3751	3/8"	Hole Size
3752	1/2"	Hole Size
3753	5/8"	Hole Size
3754	3/4"	Hole Size
3755	7/8"	Hole Size
3756	1"	Hole Size
10231	1-1/4"	Hole Size
10232	1-1/2"	Hole Size
<b>Nylon Locking Hole Plugs</b>		
18900	1/4"	Hole Size
18901	3/8"	Hole Size
18902	1/2"	Hole Size

## QUIK-SELECT II PROMOTION

For a limited time, whenever you buy any 5 Quik-Select II assortments at one time, you'll receive a **FREE 69-RACK** to hold the assortments.

That's a **\$58.56 savings**.

### 69-RACK

Empty Cabinet.  
Will hold 5 Quik-Select II Assortments.  
13-1/2" Wide x 9-1/8" Deep x 13-1/4" High  
Finish: Gray Enamel  
Keyhole slots are furnished for wall mounting.  
A handle is provided and bolt holes permit stacking.

UNIT PACKAGE: 1



**FREE!**

**FREE!**

**FREE!**



If you're looking for more variety of coverage and want to be sure that there is enough product to finish the job, Quik-Select II is your answer.



### 21257

(Chrys: 6508727-AA;  
Ford: W706815-S300)  
Black Nylon

Trunk Trim and Insulator  
Retainer  
Head Diameter: 23mm  
Stem Diameter: 8mm  
Stem Length: 20mm  
Ford Focus, Fusion, Milan,  
MKZ & Zephyr  
2006 - On

UNIT PACKAGE: 25



### 21248

(GM: 15944588)  
Tan Nylon

Headliner Retainer  
Head Diameter: 25mm  
Stem Diameter: 7.5mm  
Stem Length: 22mm  
Chevrolet Malibu 2004 - On

UNIT PACKAGE: 25



### 21228

(10444839)  
Tan Nylon

Headliner Retainer  
Head Diameter: 25mm  
Stem Diameter: 8.5mm  
Stem Length: 27mm  
Chevrolet Express Van &  
GMC Savana Van  
2004 - On

UNIT PACKAGE: 25



### 21241

(W706635-SSW)  
Black Nylon

Rocker, Pillar &  
Fender Liner Retainer  
Head Diameter: 26mm  
Stem Diameter: 7.5mm  
Stem Length: 28mm  
Ford Fusion & Taurus  
2009 - On

UNIT PACKAGE: 50



**21227**  
(25749564)  
Tan Nylon

Headliner Retainer  
Head Diameter: 45mm  
Stem Diameter: 9.5mm  
Stem Length: 20mm  
Chevrolet Express Van  
& GMC Savana Van  
2004 - On

UNIT PACKAGE: 15



**21211**  
(Toyota: 53326-08010)  
Black Nylon

Hood Insulation  
Retaining Clip  
Head Diameter: 24mm  
Stem Length: 12mm  
Fits Into 7mm Hole  
Toyota Sienna  
2009 - On

UNIT PACKAGE: 25



**21229**  
(65810-K2000)  
Black Nylon

Hood Seal  
Retaining Clip  
Head Size: 6.4mm x 16mm  
Stem Diameter: 3.5mm x 6mm  
Stem Length: 10mm  
Infiniti 130, 135, Q45 & QX4  
and Nissan Maxima & Pathfinder  
2004 - 1996

UNIT PACKAGE: 25



**21208**  
(91560-SLJ-J01)  
Gray Nylon

Door Trim Panel Retainer  
Top Head Size: 13mm  
Middle Head Size: 16mm  
Bottom Head: 18mm  
Stem Length: 12mm  
Fits Into 8.5mm Hole  
Acura RDX and Honda  
Civic, CR-V & Pilot  
2009 - On

UNIT PACKAGE: 10



**21206**  
(Honda: 91560-S6A-003)  
Orange Nylon

Rear Liftgate Retainer  
Top Head Diameter: 13mm  
Middle Head Diameter: 16mm  
Bottom Head Diameter: 18mm  
Stem Length: 14mm  
Fits 8.5mm Hole  
Honda Fit 2009 - On

UNIT PACKAGE: 15



**21240**  
(GM: 10369649)  
Green Nylon

Door Panel Retainer  
With Sealer  
Top Head Diameter: 14mm  
Middle Head Diameter: 16mm  
Bottom Head Diameter: 18mm  
Stem Diameter: 9mm  
Stem Length: 10mm  
Pontiac Torrent  
2006 - On

UNIT PACKAGE: 25



**21250**  
Not Available From O.E.M.  
Black Nylon

Seat Back & Trim Panel Retainer  
Top Head Diameter: 13mm  
Middle Head Diameter: 18mm  
Bottom Head Diameter: 16mm  
Stem Diameter: 11mm  
Stem Length: 14mm  
Jeep Commander  
2006 - On

UNIT PACKAGE: 25



**21247**  
(W709995-S300)  
Green Nylon

Lift Gate Trim Retainer  
Top Head Diameter: 15mm  
Middle Head Diameter: 19mm  
Bottom Head Diameter: 18mm  
Stem Diameter: 12mm  
Stem Length: 14mm  
Ford Flex  
2009 - On

UNIT PACKAGE: 25



**21242**  
(11562250)  
White Nylon

Rocker Panel  
Moulding Clip  
With Sealer  
Top Head Size: 12mm x 20mm  
Bottom Head Size: 12mm x 20mm  
Stem Length: 11mm  
Fits Into 9mm Hole  
GMC Acadia  
2007 - On

UNIT PACKAGE: 15



**21246**  
(GM: 22690838)  
Black Nylon

Door trim  
Push-Type Retainer  
Head Diameter: 12mm  
Stem Length: 17mm  
Fits Into 6mm Hole  
Chevrolet Malibu &  
Pontiac G6  
2004 - On

UNIT PACKAGE: 25



**21238**  
(22718369)  
Black Nylon

Fuel Tank Shield  
& Miscellaneous  
Push-Type Retainer  
Head Diameter: 26mm  
Stem Length: 12mm  
Fits Into 10mm Hole  
Chevrolet Malibu & Trail Blazer  
2004 - On

UNIT PACKAGE: 25

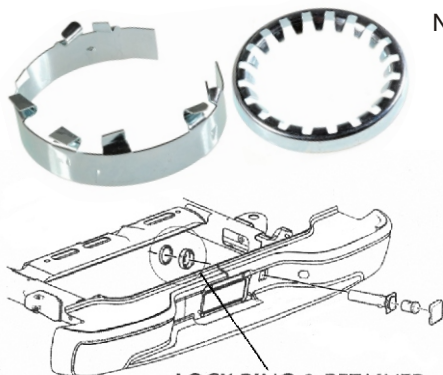

**LOCK RING & RETAINER**

The retainer and ring are damaged whenever the bumper is removed.

Not Actual Size

**21290**

(15769308 - Retainer,  
15040331 - Ring)  
Zinc

Spare Tire  
Lock Cylinder Housing Retainer  
& Lock Ring Kit  
Retainer O.D.: 72mm  
Lock Ring O.D.: 57mm  
GM C/K, Denali, Sierra,  
Silverado, Suburban,  
Tahoe and Yukon  
1999 - On

UNIT PACKAGE: 5 KITS



**21239**

(W708319-S300)  
White Nylon

Front Bumper  
Screw Grommet  
With Sealer  
M4.8 (#10) Screw Size  
Head Diameter: 16mm  
Stem Length: 24mm  
Ford Fusion  
2009 - On

UNIT PACKAGE: 25



**21224**

(Ford: F50Y-14603-A)  
Black Nylon

Headlight and Tail Light Grommet  
Head Size: 18.5mm x 21.5mm  
Stem Length: 18mm  
Fits Into 9.5mm x 21.5mm Hole  
Ford Explorer, Navigator and  
Super Duty  
Pick-Up 2003 - On

UNIT PACKAGE: 25

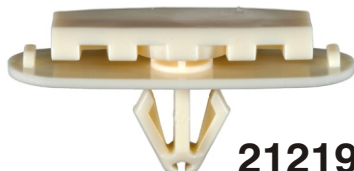

**21219**

Not Available From O.E.M.  
Yellow Nylon

Fender Flare Moulding Clip  
Top Head Size:  
14.5mm x 33.5mm  
Bottom Head Size:  
15mm x 45mm  
Stem Length: 14mm  
Fits Into 11mm Hole  
Ford Truck F-450 &  
F-550 2009 - On

UNIT PACKAGE: 10



**21230**

Not Available From  
O.E.M.  
White Nylon

Fender Flare Moulding Clip  
Top Head Size: 14mm x 34mm  
Bottom Head Size: 14mm x 33mm  
Stem Length: 14mm  
Fits Into 9mm Hole  
Ford Explorer  
2007 - On

UNIT PACKAGE: 25



**21215**

(W710791-S437)  
Zinc

Quarter Glass & Luggage Rack  
Specialty Insert With Sealer  
Thread: M6-1.0  
Grip: .51mm - 3.18mm  
Head Diameter: 13mm  
Hex: 9.5mm (3/8")  
Can be set with Auveco Tool 11805  
Ford Expedition & Navigator  
2007 - On

UNIT PACKAGE: 15



**21236**

(6508072-AA)  
Black Nylon

Headlight Nylon Nut  
M5.5 (#12) Screw Size  
Head Size: 15mm x 15mm  
Stem Length: 10mm  
Fits Into 10.5mm x 11mm Hole  
Jeep Grand Cherokee  
& Commander  
2005 - On

UNIT PACKAGE: 50



**21231**

(4784018-AA)  
Green Nylon

Door Panel Grommet  
Head Diameter: 19mm  
Stem Length: 12mm  
Fits Into 9mm Hole  
Use With Auveco #20274  
Chrysler LH Series  
2000 - On

UNIT PACKAGE: 25



**21213**

Not Available From O.E.M.  
Black Nylon

Tail Light Assembly Grommet  
Head Diameter: 19mm  
Stem Length: 11mm  
Fits Into 12mm Hole  
Dodge Pick-Ups 1500 & 2500  
Series 2006 - On

UNIT PACKAGE: 25



**21223**

(Chrysler: 6509288AA)  
Black Nylon

Rocker Moulding Clip With Sealer  
Upper Head Size: 21mm x 22mm  
Bottom Head Size: 22mm x 22mm  
Stem Length: 9mm  
Chrysler Grand Caravan and Town &  
Country 2008 - On

UNIT PACKAGE: 10



**21187**

(Chrysler: 4806226-AA;  
GM: 11562364)  
Zinc

Front & Rear Bumper and Grille  
Fastener  
#6 Screw Size  
Width: 10mm  
Overall Height: 18mm  
Buick Lucerne and Cadillac  
CTS & STS 2005 - On  
Chrysler 300, Dodge Nitro and Jeep  
Commander 2005 - On

UNIT PACKAGE: 15



Groove 75  
PK3

**21193**

(Strat: 5912114;  
GM: 19207416)  
Transponder Key  
For  
Anti-Theft Security  
Cadillac CTS & STS  
2007 - 03

UNIT PACKAGE: 1



**21209**

(Acura: 91601-STX-A00)  
Gray Nylon

Rear Hatch  
Screw Grommet  
With Sealer  
Screw Size: M3.5 (#6)  
Top Head Dia: 12mm  
Bottom Head Dia: 14mm  
Stem Length: 10mm  
Acura MDX  
2009 - On

UNIT PACKAGE: 10



**21204**

(Acura: 75315-STK-A01  
Honda: 75315-S9A-004)  
White Nylon

Front & Rear Door  
Exterior Trim  
Moulding Clip  
Top Head Size:  
12mm x 15mm  
Bottom Head Size:  
14mm x 20mm  
Stem Length: 9mm  
Acura RDX  
Honda CR-V  
2009 - 07

UNIT PACKAGE: 15



**21207**

(Honda: 91513-SMG-E11)  
White Nylon

Fender Moulding Clip  
Top Head Size:  
7mm x 7mm  
Bottom Head Size:  
10mm x 19mm  
Stem Length: 6mm  
Honda CR-V  
2009 - On

UNIT PACKAGE: 25



**21186**

(Honda:  
75305-SHJ-003)  
White Nylon

Front and Side Door Exterior Trim  
Moulding Clip  
Width: 13mm  
Length: 14mm  
Height: 13mm

Honda Odyssey 2005 - On

UNIT PACKAGE: 15



**21216**

(91502-S9A-003)  
White Nylon

Front & Rear Bumper  
Moulding Clip With  
Sealer

Head Size: 14mm x 26mm  
Stem Length: 15mm  
Height: 28mm

Honda CR-V 2002 - On

UNIT PACKAGE: 10



**21205**

(Honda: 90682-SDA-A01)  
Black Nylon

Rear Bumper Screw Grommet  
Screw Size: M4.8 (No.10)  
Head Size: 14mm x 14mm  
Stem Length: 14mm

Honda Civic 2009 - On

UNIT PACKAGE: 15



**21232**

(86910-21010)  
Natural Nylon

Bumper Screw  
Grommet  
With Sealer

M4.8 (#10) Screw Size  
Head Diameter: 18mm  
Stem Length: 21mm  
Hyundai Azera 2009 - On

UNIT PACKAGE: 15



**21233**

(86157-37000)  
Black Nylon

Hood Mounting  
Push-Type Retainer  
Head Diameter: 10mm  
Stem Length: 13mm  
Fits Into 5mm Hole  
Hyundai Azera 2009 - On

UNIT PACKAGE: 25



**21243**

Not Available From  
O.E.M.  
White Nylon

Moulding Clip  
Head Diameter: 15mm  
Stem Length: 14mm  
Fits Into 9mm Hole  
Infiniti 2006 - On

UNIT PACKAGE: 15



**21255**

(Lexus: 75545-53010)  
Blue Nylon

Windshield Clip  
Width: 15mm  
Length: 55mm

Lexus ES250 & IS250 2008 - On

UNIT PACKAGE: 10



**21192**

(Nissan: 01553-05323)  
Black Nylon

Cowl, Bumper & Fender Liner  
Push-Type Retainer  
Head Diameter: 20mm  
Stem Length: 12mm  
Fits Into 8mm Hole  
Infiniti FX35, FX45, G35  
and Nissan  
2003 - On

UNIT PACKAGE: 10



Not Actual Size

**21259**

(Nissan: 24225-89960)  
Black Nylon

Cable Strap  
Overall Length: 200mm (8")  
Width: 8mm (5/16")  
Max. Bundle Diameter: 55mm (2-3/16")  
Snaps Into 8mm (5/16") Hole  
Nissan  
2005 - On

UNIT PACKAGE: 25



**21194**  
 (Toyota: 61118-35010)  
 Black Nylon  
 Front Fender Upper Seal  
 Moulding Clip  
 Head Size: 18mm x 18mm  
 Stem Length: 13mm  
 Fits Into 9mm Hole  
 Toyota FJ Cruiser 2007 - On  
 UNIT PACKAGE: 15

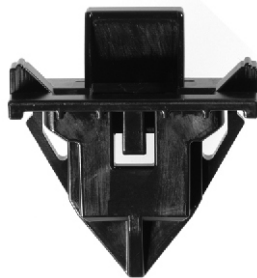

**21235**  
 (61992-35010)  
 Black Nylon  
 Front Fender/Sheet Metal  
 Upper Seal Moulding Clip  
 Top Head Size: 13mm x 31mm  
 Overall Height: 34mm  
 Toyota FJ Cruiser  
 2007 - On  
 UNIT PACKAGE: 10



**21221**  
 (Toyota: 52115-0C090)  
 Black Nylon  
 Front Bumper Moulding Clip  
 Head Size: 25mm x 74mm  
 Overall Height: 17mm  
 Stem Length: 15mm  
 Toyota Tundra 2009 - On  
 UNIT PACKAGE: 10



**21234**  
 (61991-35010)  
 Black Nylon  
 Front Fender/Sheet Metal  
 Upper Seal Moulding Clip  
 Top Head Size: 9mm x 31mm  
 Overall Height: 30mm  
 Toyota FJ Cruiser  
 2007 - On  
 UNIT PACKAGE: 10



**21217**  
 (76924-47010)  
 Black Nylon  
 Rocker Panel  
 Moulding Clip  
 Head Size: 43mm x 54mm  
 Overall Height: 26mm  
 Toyota Prius  
 2009 - On  
 UNIT PACKAGE: 5



**21191**  
 (Toyota: 90189-05142)  
 Natural Nylon  
 Headlight Mounting  
 Nylon Nut  
 Screw Size: M4.2 (#8)  
 Head Diameter: 17mm  
 Stem Length: 8mm  
 Fits Into 9mm Square Hole  
 Toyota & Scion  
 2001 - On  
 UNIT PACKAGE: 25



**21237**  
 (Toyota: 53867-47020)  
 Dark & Light Gray Nylon  
 Front Fender Retainer  
 With Sealer  
 Overall Height: 18mm  
 Fits Into 10mm  
 x 16mm Hole  
 Toyota Prius  
 2004 - On  
 UNIT PACKAGE: 10



**21218**  
 (90467-05063-C0)  
 Black Nylon  
 Front Bumper  
 Push-Type Retainer  
 Head Diameter: 11mm  
 Stem Length: 8mm  
 Fits Into 5mm Hole  
 Toyota Corolla 2009 - On  
 UNIT PACKAGE: 15



**21226**  
 (Toyota: 75867-02010)  
 Black Nylon  
 Rocker Moulding Retainer  
 Top Head Diameter: 13mm  
 Bottom Head Diameter: 18mm  
 Stem Diameter: 9mm  
 Stem Length: 10mm  
 Toyota Corolla 2009 - On  
 UNIT PACKAGE: 25



**21225**  
 (53888-48010)  
 Black Nylon  
 Wheel Opening  
 Push-Type Retainer  
 Head Diameter: 18mm  
 Stem Length: 14mm  
 Fits Into 7mm Hole  
 Toyota Highlander  
 2001 - On  
 UNIT PACKAGE: 5



**21201**  
 (Toyota: 90467-07211)  
 Black Nylon  
 Bumper, Radiator Cover  
 and Grille  
 Push-Type Retainer  
 Head Diameter: 19mm  
 Stem Length: 8mm  
 Fits Into 7mm Hole  
 Lexus IS & LS, Scion and Toyota  
 Avalon, Camry & Highlander  
 2005 - On  
 UNIT PACKAGE: 10



**21251**  
 (VW: 6Q0-868-243)  
 Black & White Nylon  
 Trim Panel  
 Push-Type Retainer  
 With Sealer  
 Head Diameter: 22.5mm  
 Stem Length: 12mm  
 Fits Into 8mm Hole  
 Volkswagen Golf, Jetta, Passat,  
 Phaeton, Rabbit & Tiguan  
 2004 - On  
 UNIT PACKAGE: 15